



2003 Full Year Results
February 2, 2004

Gérard Hauser

This presentation contains forward-looking statements relating to the Company's expectations for future financial performance, including sales and profitability.

Such forward looking statements involve known and unknown risks, uncertainties and other factors which may cause our actual results, performance and achievements to be materially different from those implied in the forward-looking statements.

Such expectations depend amongst others on the following assumptions and associated risks: (1) an increase in demand concomitant worldwide economic growth; (2) recovery in the construction and industrial sectors, as well as the winding wire activity; (3) telecom operators return to normal levels of infrastructure spending, particularly in export markets; (4) the effect of metal price and currency fluctuations will be neutral; (5) successful management of risks associated with sales in project activities; (6) the company will be able to reduce its cost base through realization of restructuring actions in the anticipated time frame; (7) the company will be able to achieve productivity improvements; and (8) the company will successfully integrate acquisitions.

Investor relations:

Michel Gédéon

Tel: 33 1 56 69 85 31

E-mail: michel.gedeon@nexans.com

Fax: 33 1 56 69 86 35

- **Issues identified since June 30, 2003**

- Regulation: new IAS/IFRS rules as of January 1st, 2005
- Internal:
 - ✓ Assets completely depreciated even if still in service
 - ✓ For some activities: high level of assets compared to profitability
- External: depreciation periods significantly shorter than peers

- **Possible options**

- Extend the remaining useful lives with no impact as of January 1st, 2003
- Adopt CRC 2002-10 standard as soon as January 1st, 2003 (mandatory as of 1/1/04) which is an early application of IAS 16 and 36

- **Chosen option : *CRC 2002-10 « relating to amortization and depreciation of assets »***

- Separate useful life for each major component of an asset
- Impairment tests on all tangible and intangible assets

	<u>Before</u>	<u>After</u>
● Impacts on balance sheet (January 1st, 2003)		
■ Goodwill	45	39
■ Property, Plant & Equipment	799	824
■ Working Capital	616	605
■ Shareholder's equity (group share)	991	1,001
● Impacts on 2003 P&L		
■ Operating Profit	58	91
<i>as a consequence of reduced depreciation charge of 33 M€ in 2003 (and following years)</i>		
● Cash neutral		

2003

Business conditions remained challenging

OPERATIONAL

- Telecom sales stabilized
- Energy Infrastructure outstanding
- Winding Wires & General Market deteriorate further

PERIMETER

- Integration of Kukdong & Furukawa
- Other options explored

FINANCIAL

- Breakeven point lowered further
- Debt Level 29 M€ lower than 2002 (61 M€ excluding effect of acquisitions).
- 21 M€ « Write down » on Winding wires

SLIGHT IMPROVEMENT IN PROFITABILITY

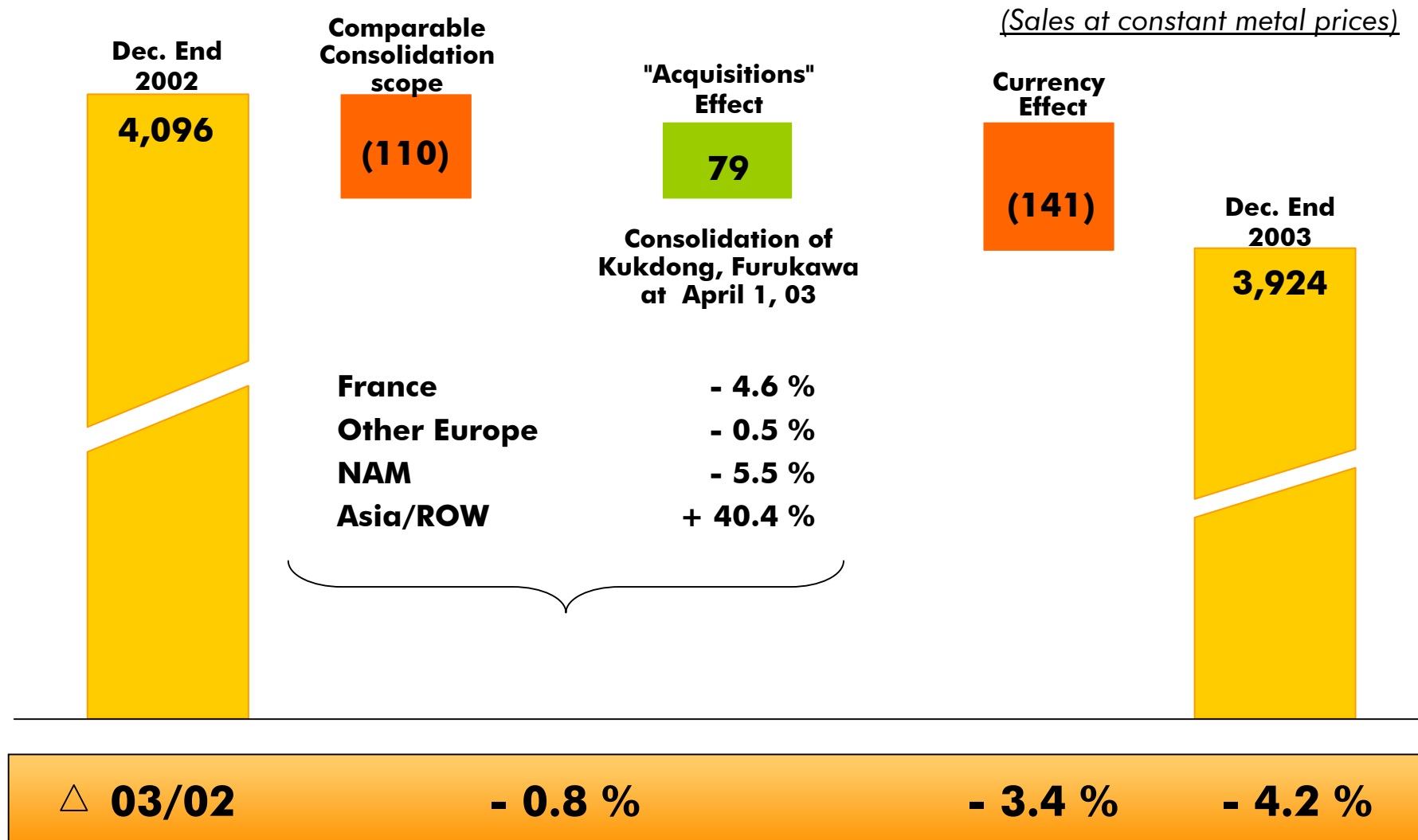

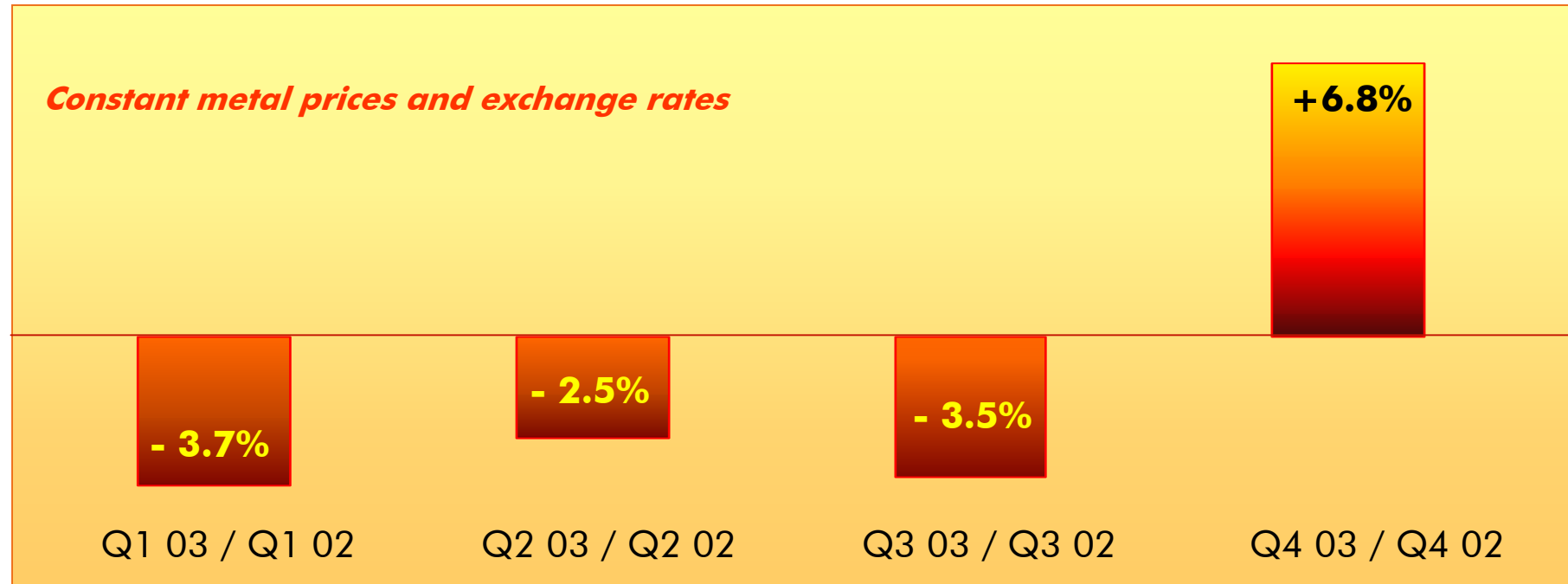

- Q4 = 3.9% organic year-on-year growth (Q4 03 / Q4 02)
- Q4 = 9.7% organic quarter-on-quarter growth (Q4 03 / Q3 03)
- Q4 = Growth impacting almost all sectors

(in Million €)	2002	2003 <i>Before CRC 2002-10</i>	2003
Sales at current metal prices	4,302	4,046	4,046
Sales at constant metal prices	4,096	3,924	3,924
Sales at constant metal prices and exchange rates	3,955	3,924	3,924
EBITDA	201 (4.9%)	190 (4.8%)	190 (4.8%)
Operating Profit	56	58	91
Operating Profit Margin	1.4 %	1.5 %	2.3 %
Net Income excluding Winding Wires write down	(40)	(10)	22
Net Income	(40)	(31)	1
Earnings per Share (in €)	(1.78)	(1.47)	0.06
Net Debt	52	23	23

Sales at constant metal prices and exchange rates (in Million €)

	Full Year 2002			Full Year 2003				
	Sales	OP	% OP/Sales	Sales	OP <i>Before CRC 2002-10</i>	% OP/Sales	OP	% OP/Sales
Energy	2,089	71	3.3 %	2,143	65	3 %	78	3.6 %
Telecom	539	(35)	- 6 %	545	(7)	- 1.3 %	(1)	-
Electrical Wires	1,029	12	1.1 %	957	(3)	- 0.3 %	10	1 %
Distribution	298	16	5.1 %	279	13	4.7 %	13	4.7 %
Other	0	(8)	-	0	(10)	-	(9)	-
TOTAL	3,955	56	1.4 %	3,924	58	1.5 %	91	2.3 %

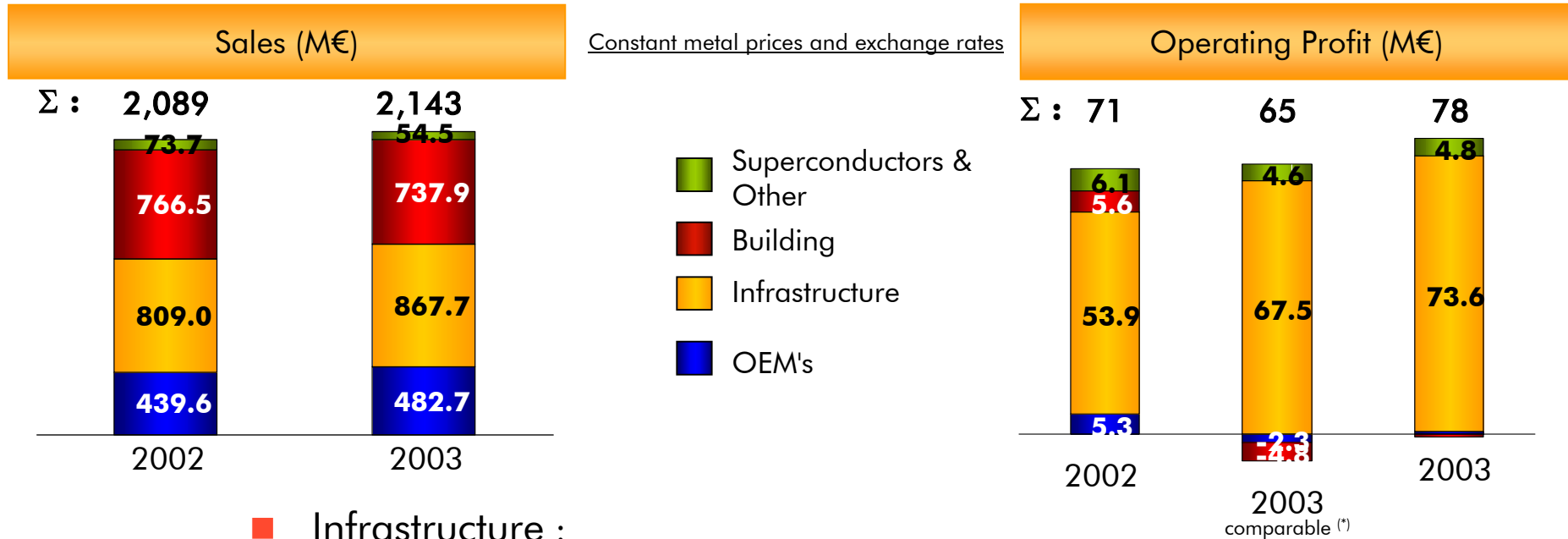

- Infrastructure :
 - Very strong growth in HV contracts and umbilical cables
- OEM's :
 - Low levels of investment in Europe and technical problem with a contract
 - Encouraging demand in Asia (Marine cables)
- Building :
 - Italy, France, Spain: volume and prices under pressure – corrective measures under way

(*) Before application of CRC 2002-10

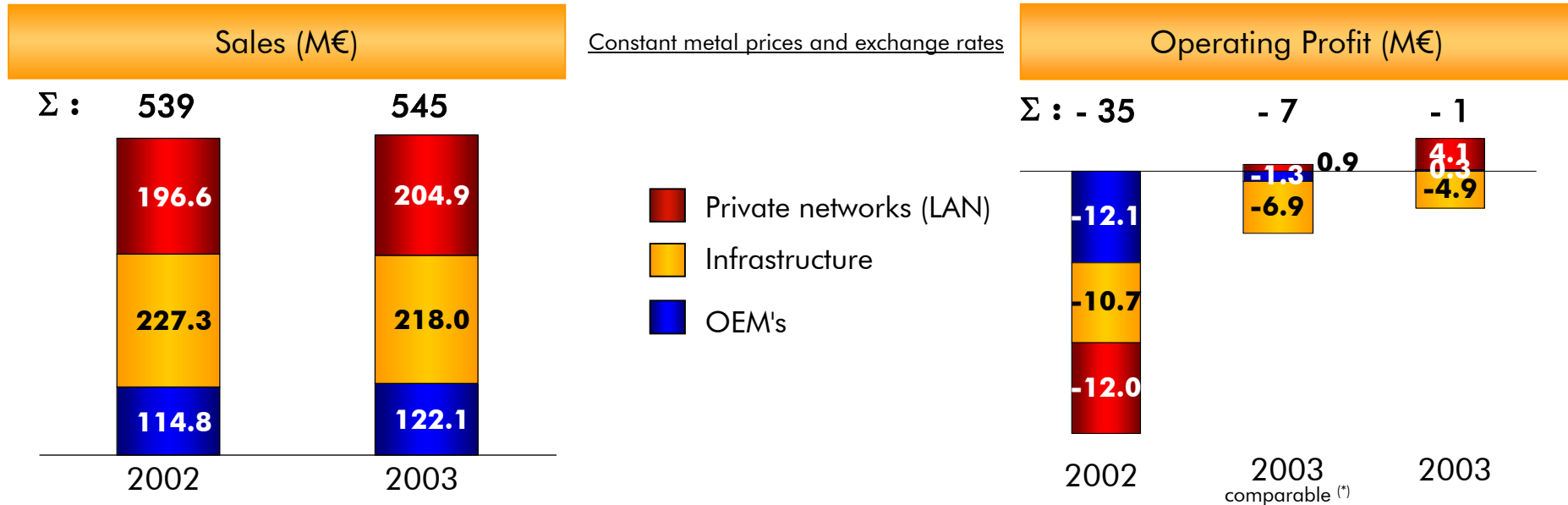

- Stable sales
- Positive effect of restructuring
- Breakeven delayed due to weak infrastructure sales in second half of 2003

(*) Before application of CRC 2002-10

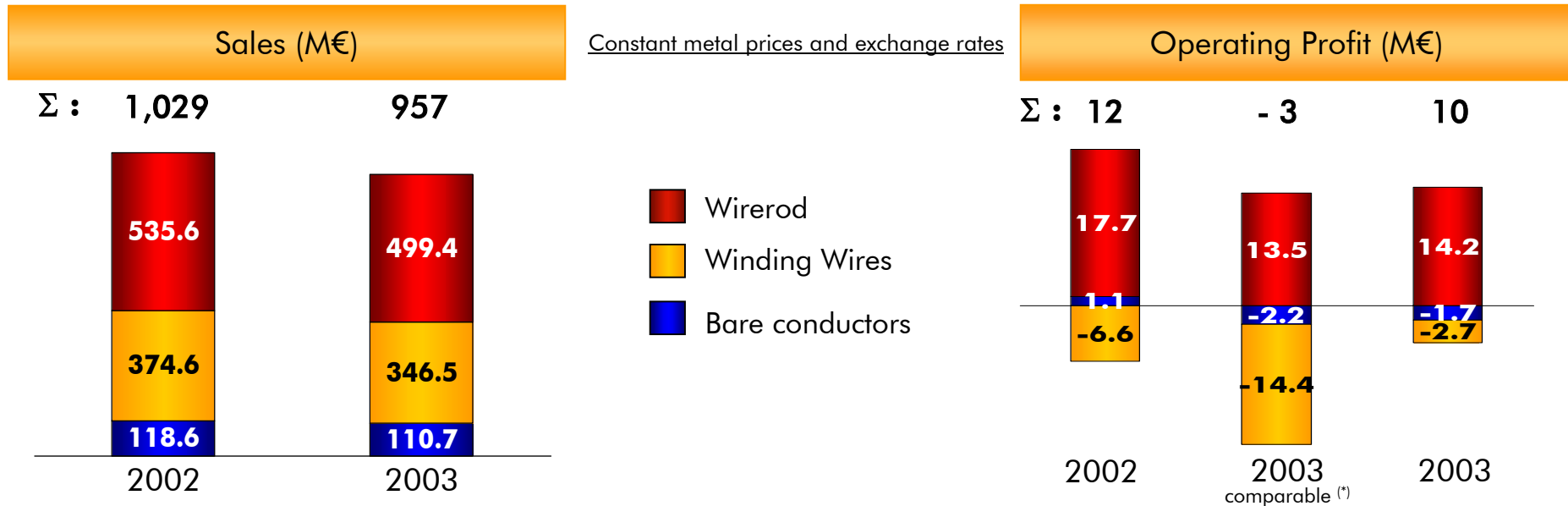

- Wirerod :
 - Leadership confirmed despite difficult economic environment
- Winding wires :
 - 2003 restructuring will benefit to 2004
 - Divestiture under review

(*) Before application of CRC 2002-10

Sales at constant metal prices and exchange rates (in Million €)	Full Year 2002			Full Year 2003				
	Sales	OP	% OP/Sales	Sales	OP <i>Before CRC 2002-10</i>	% OP/Sales	OP	% OP/Sales
Europe	3,040	29	1 %	2,959	32	1.1 %	54	1.8 %
North America	697	19	2.7 %	659	15	2.3 %	22	3.3 %
Asia	107	4	3.8 %	175	10	5.6 %	12	7 %
Rest of World	111	4	3.4 %	131	1	1.1%	3	2.6 %
TOTAL	3,955	56	1.4 %	3,924	58	1.5 %	91	2.3 %

2003 Sales : **2,959 M€^(a)**

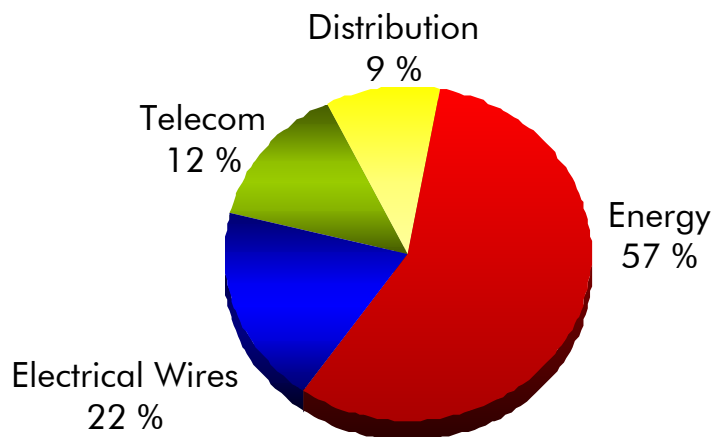

Sales (M€)^(a)

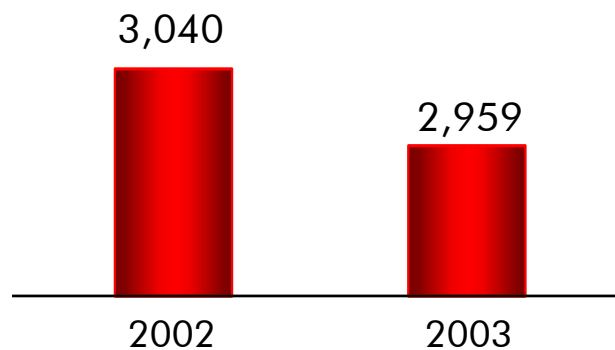

^(a) Sales at constant metal prices and exchange rates

^(*) Before application of CRC 2002-10

- Strong points to build on
 - HV and umbilical cables (Norway, Belgium)
- Weak points to remedy
 - Loss in cables for building (General Market)
 - Weakness of specialty products (private network cables and winding wires)
- In summary: profitability to be improved

Operating Profit (M€)

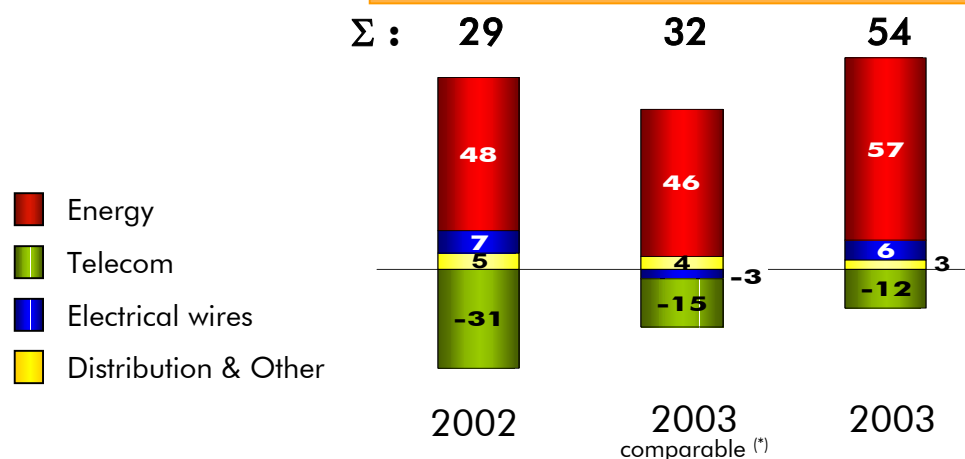

2003 Sales : **659** M€^(a)

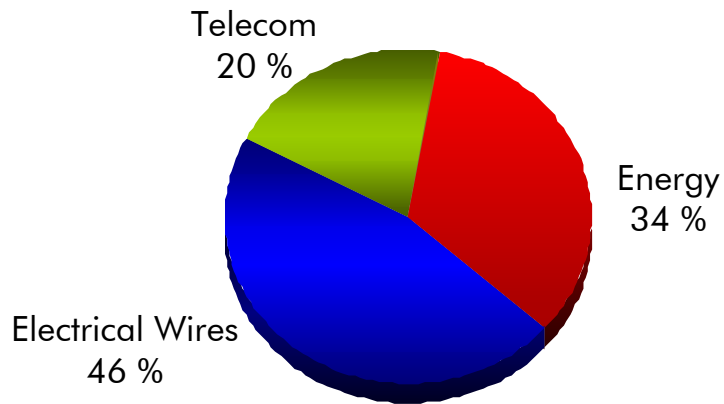

- Positive trend in LAN markets
- LV for Building: profitable situation
- Realize strong potential in energy networks
- Winding wires business very costly

Sales (M€)^(a)

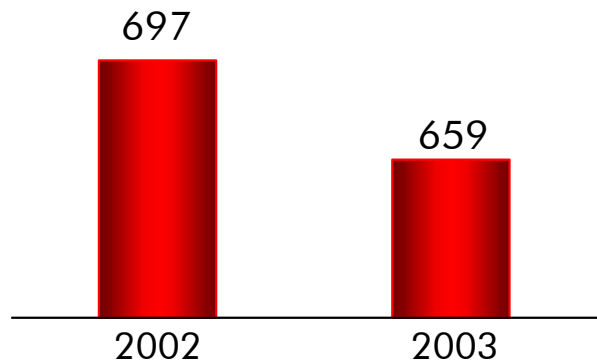

^(a) Sales at constant metal prices and exchange rates

^(*) Before application of CRC 2002-10

Operating Profit (M€)

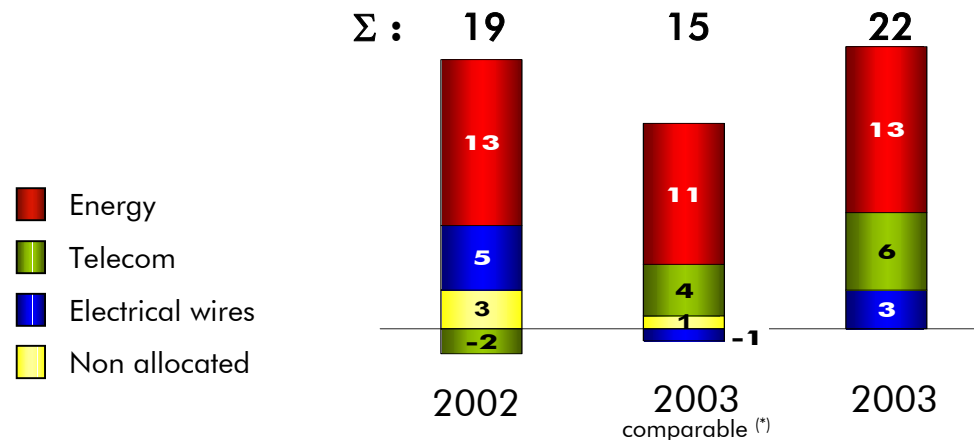

2003 Sales: **175 M€^(a)**
 Sales by Destination : **235 M€**

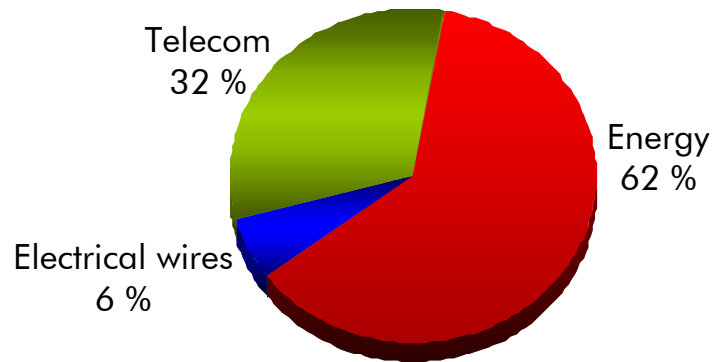

- Strong growth 03 vs 02: +63 %
- Marine cables sector penetrated (Korea)
- Very encouraging demand in China and Vietnam
- Sales of infrastructure cables (Energy and Telecom) to be developed in Korea

Sales (M€)^(a)

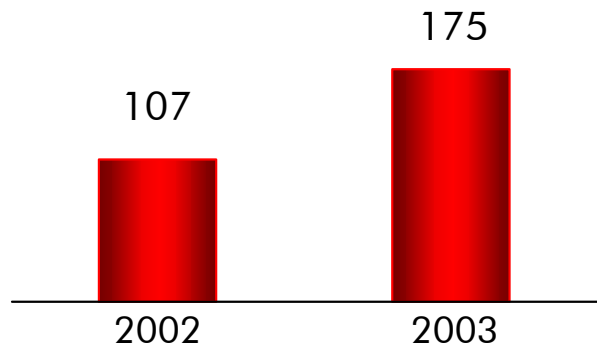

Operating Profit (M€)

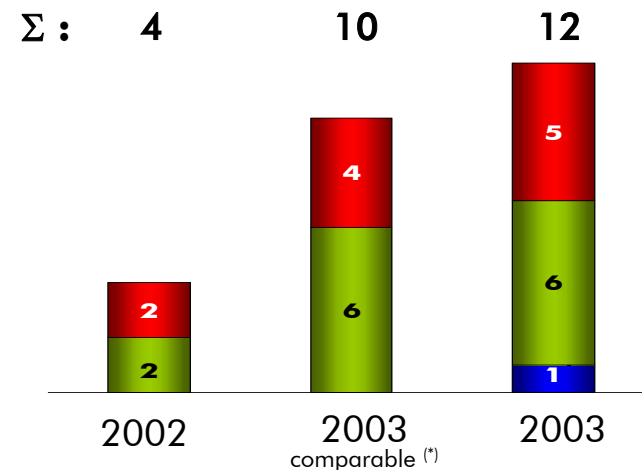

^(a) Sales at constant metal prices and exchange rates

^(*) Before application of CRC 2002-10

Financial Results

Frédéric Vincent

- **Decision to apply for CRC 2002-10 made in June 2003**
 - Component approach: "If, from the start, one or several of these elements (constituents of the asset) each had different applications, **each element should be recorded separately in the accounts** and **a separate useful life** should be drawn up for each component"
 - Methods for evaluating impairment of tangible and intangible assets :
 - ✓ "In case of signs of overvaluation, an impairment test has to be carried out"
 - ✓ "If the current value becomes lower than the net book value, **the latter is adjusted to the current value** by means of a an impairment "
 - Regulation applies from January 1, 2005 with optional application from January 1, 2003
 - " The impact of the change as assessed at the opening date, after taxes, is **booked to retained earnings** ..."
- **Measures anticipating the application of IAS standards on January 1, 2005 (IAS 16 and 36)**

Component approach and impairment

(in Million €)	<u>Impact on Shareholder's equity at 1/1/03</u>		<u>Impact</u>
	<u>Components</u>	<u>Impairment</u>	<u>2003 Operating Profit</u>
● ENERGY	137	(108)	13
			<ul style="list-style-type: none"> Building Infrastructure Italy OEM's Germany
● TELECOM	53	(37)	6
			<ul style="list-style-type: none"> OEM's France Infrastructure (Switzerland, Korea)
● ELECTRICAL WIRES	64	(92)	13
			<ul style="list-style-type: none"> Winding wires (Europe, North America) Bare conductors
● DISTRIBUTION & OTHER	3	(1)	1
● Impact on Shareholder's Equity Before Tax	19		33
● Impact on Shareholder's Equity After Tax	9		
● of which Group share	10		

Main impacts currently identified (preliminary estimates)

- **Employee benefits obligations (IAS 19)**
 - Negative impact on shareholder's equity : ~100 M€

- **Sale without recourse of receivables (IAS 32 /39)**
 - Increase in debt and working capital : ~100 M€

- **Currencies and copper hedging (IAS 32/39)**
 - Impact under evaluation

- **Copper and non ferrous metal inventory valuation (IAS 2)**
 - Abolition of LIFO method

- Sales located in Europe (cost base in €) = 68 % (no risk)
- Subsidiaries located in dollar area (cost base in dollar) = 20 % of sales (conversion impact)
- Exports to dollar area = 4 % of sales (squeeze on margin)

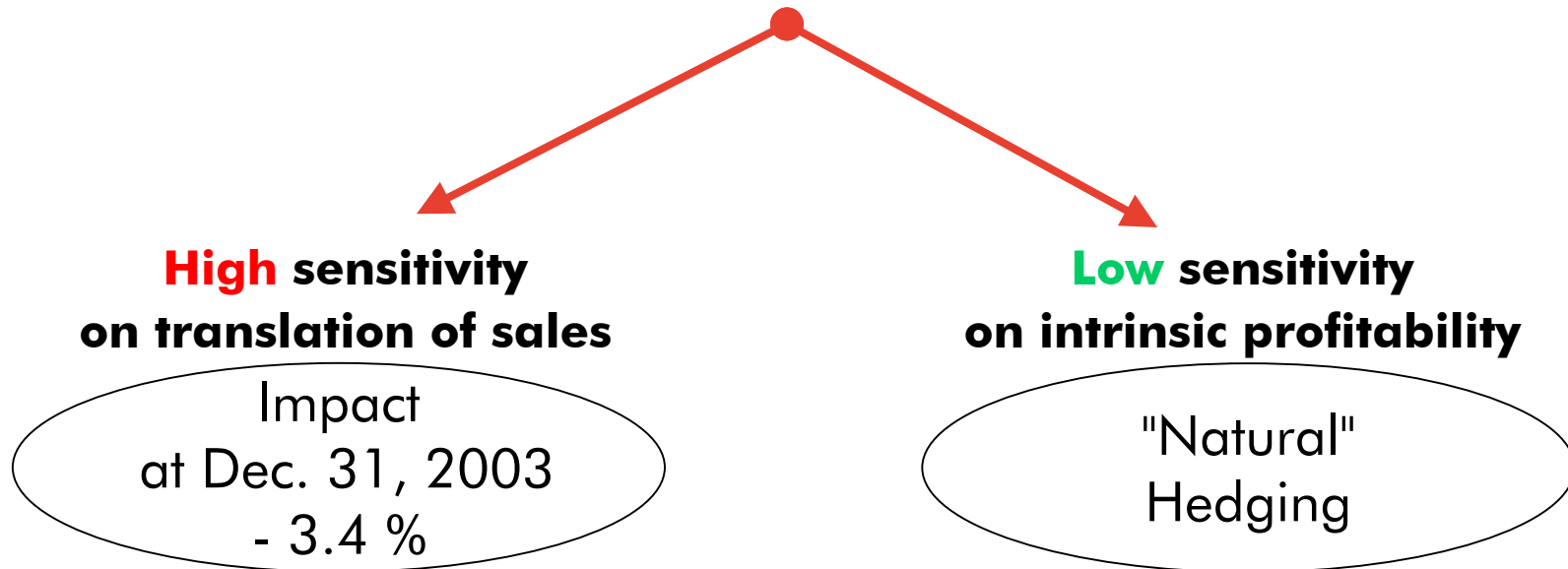

Average sensitivity on translation :

- of OP : ~ 2 M€
- of Cash Flow : ~10 M€

(in Million €)	2002	2003
Sales at constant metal	4,096	3,924
Margin on variable costs	1,058	1,021
<i>Margin on variable costs (%)</i>	<i>25.8 %</i>	<i>26 %</i>
Indirect costs	(857)	(831)
EBITDA ^(*)	201	190
<i>EBITDA Margin (%)</i>	<i>4.9 %</i>	<i>4.8 %</i>
Depreciation	(145)	(99)
Operating profit	56	91
<i>Operating profit margin (%)</i>	<i>1.4 %</i>	<i>2.3 %</i>
Financial charge	(31)	(31)
Restructuring	(90)	(41)
Other revenues	23	(2)
Income before tax	(43)	18
Income Tax	10	8
Goodwill amortization	(2)	(14)
Minority interests	(5)	(10)
Net Income	(40)	1
Net Income excluding Winding Wires adjustment	(40)	22

(*) Operating profit before depreciation

Restructuring Plan 02 / 03

(in Million €)

Total Costs

Energy 52

Telecom 47

Electrical Wires 24

Distribution & Other 7

TOTAL 130

Indirect Costs(*)

(Comparable consolidation scope & exchange rates)

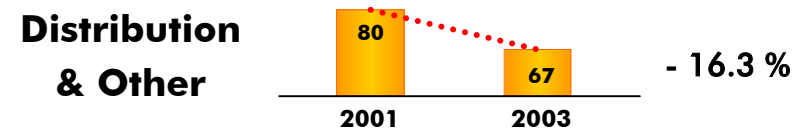
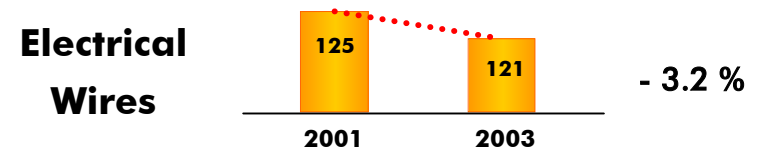
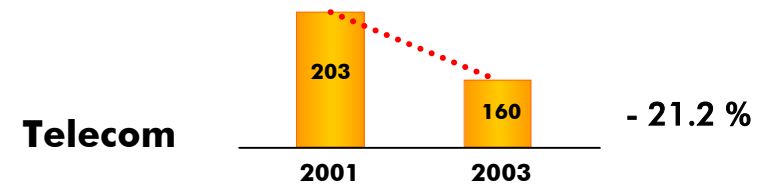
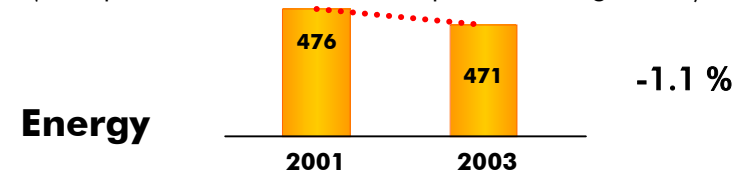

TOTAL comparable	884	819	- 7.4 %
Adjustment Consol. Scope / Currency :	39	12	
TOTAL	923	831	- 10 %

(*) Indirect production costs, R&D and SG&A without depreciation

in Million €

Net Debt at December 31, 2002

(52)

Operating cash flows

72

Operating position at December 31, 2003

20

Increase in non-recourse sale of receivables

16

Copper price increase on working capital

(24)

Cash costs of acquisitions/ share buyback

(35)

Net Debt at December 31, 2003

(23)

■ Operating cash flow = 124% of Operating Profit

in Million €	2002	2003
Net Income (including Minority interests)	(35)	11
Depreciation and Amortization	148	113
Other non cash items	30	7
Operating Cash Flow (*)	143	131
Change in Working Capital	39	47
Capital expenditure, net	(84)	(52)
Restructuring expenses	(57)	(38)
<i>Subtotal</i>	<i>41</i>	<i>88</i>
Cash impact of (acquisition)/divestiture	3	(32)
Share Buy-Back	(25)	(3)
Dividends paid	(15)	(8)
Other	15	(16)
Net (increase)/decrease in Debt	19	29

(*) Cash flow provided by operations excluding restructuring expenses

in Million €	Dec 31, 02	Dec 31, 03
Intangible assets	45	27
Property, Plant & Equipment	799	784
Investments & other non-current assets	67	68
Total non-current assets	911	879
Working capital	616	569
Total to Finance	1,527	1,448
Net debt ^(*)	52	23
Reserves	396	380
Minority interests	88	103
Shareholder's equity	991	942
Total Financing	1,527	1,448
^(*) after non-recourse sale of receivables : (AMF Recommendation, December 02)	93	109

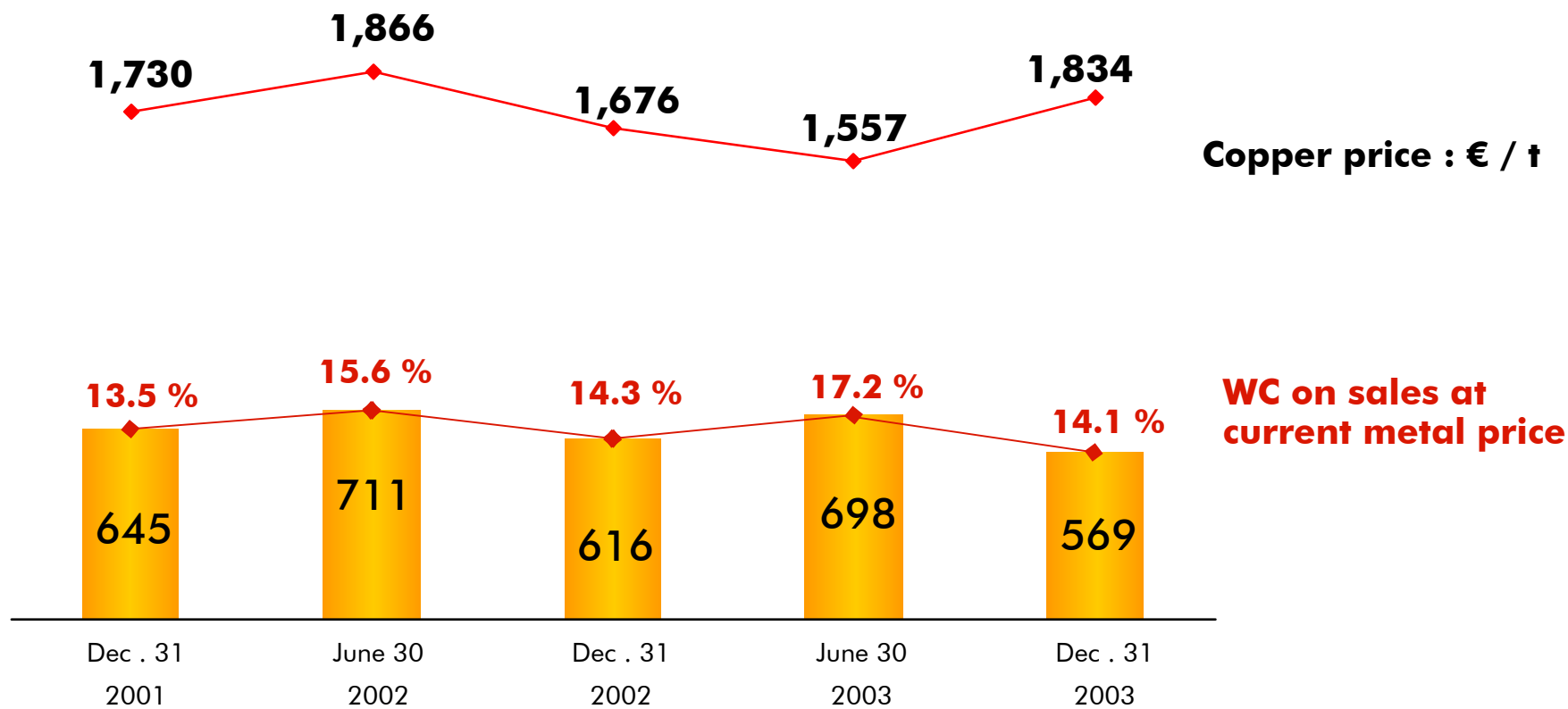

Outlook

- Create conditions for sustainable profitability
 - Eliminate loss contributors
 - Capitalize on existing upstream integration
 - Enrich downstream offering
 - Improve geographical proximity to clients
- Develop growth segments
- Explore changes to activities portfolio



Nexans Attractiveness
for Customers, Shareholders and Employees

Why did they happen ?

- Overload of networks (lack of capex for maintenance)
- Overheating and lengthening of overhead lines
- Short circuits due to collisions with obstacles
- Overload on the other lines ("domino" effect)

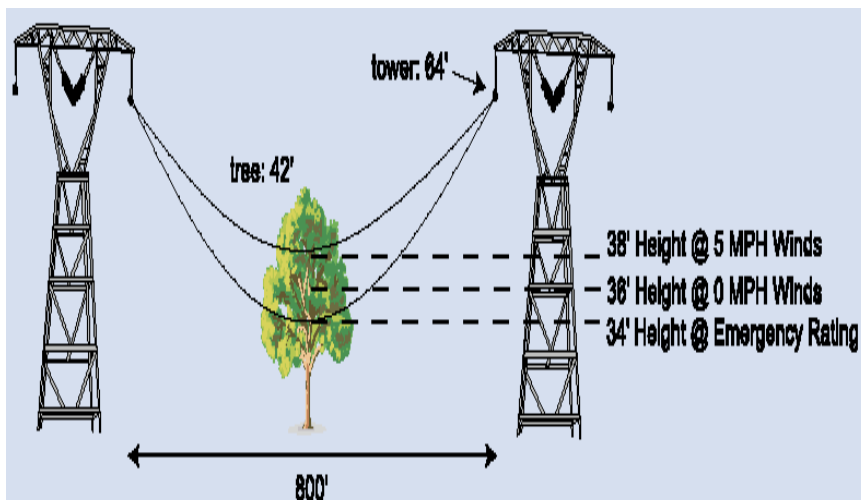
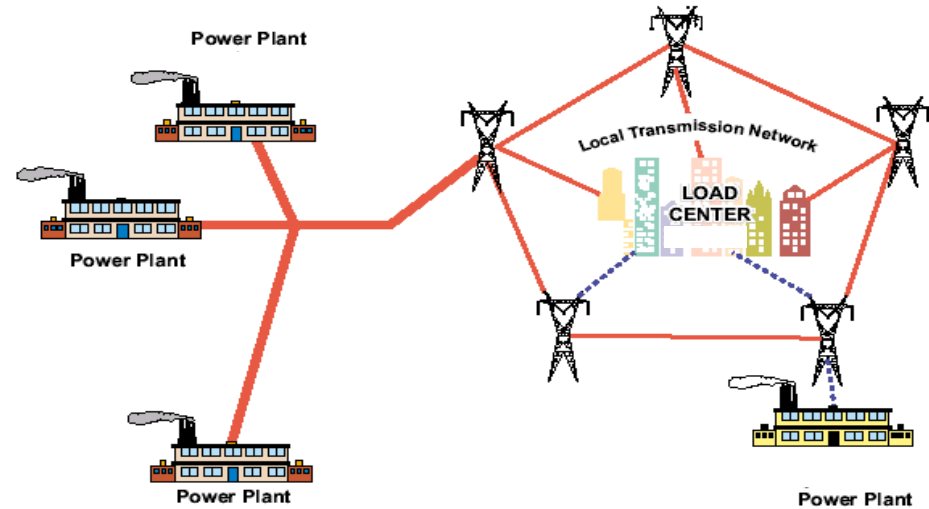

What opportunities for Nexans ?

- Priority 1: Coordination between networks operators
 - No impact for cable makers
- Priority 2 : Stronger control and monitoring
 - Limited impact for cable makers (Optical fiber captors, supercomputing storage)
- Priority 3 : Maintenance and Capex
 - Strong impact for cable makers (underground +overhead)

Challenges

Immediate

- Strong weight of commodities ...
- ... versus incomplete Telecom product range
- Strong growth in Asia

Possible answers

- Sale of winding wires business under consideration
- Add a Fiber-optic business
- Strengthen Kukdong
- Build a new plant in China

Limits

Long Term

- Overcapacities with slow restructuring

- Strategic move in the direction of Industry consolidation

- Diversification

- Acceptable Dilution
- Synergies to find
- Adequate financing

- Can only be opportunistic

- Increase of sales of approximately 3 % at constant exchange rates
- Improvement in operating profitability
- 2003 Dividend : 0.20 €/share (same level than 2002) to be proposed for the decision of the shareholder's meeting
- Restructuring charge back to normal levels of 25 to 30 M€ (mostly relating to "commodity" products)
- Capex of around 80 to 90 M€
- Continue Cash flow generation

Mexans