

FTTH FACADE SOLUTION OFFER

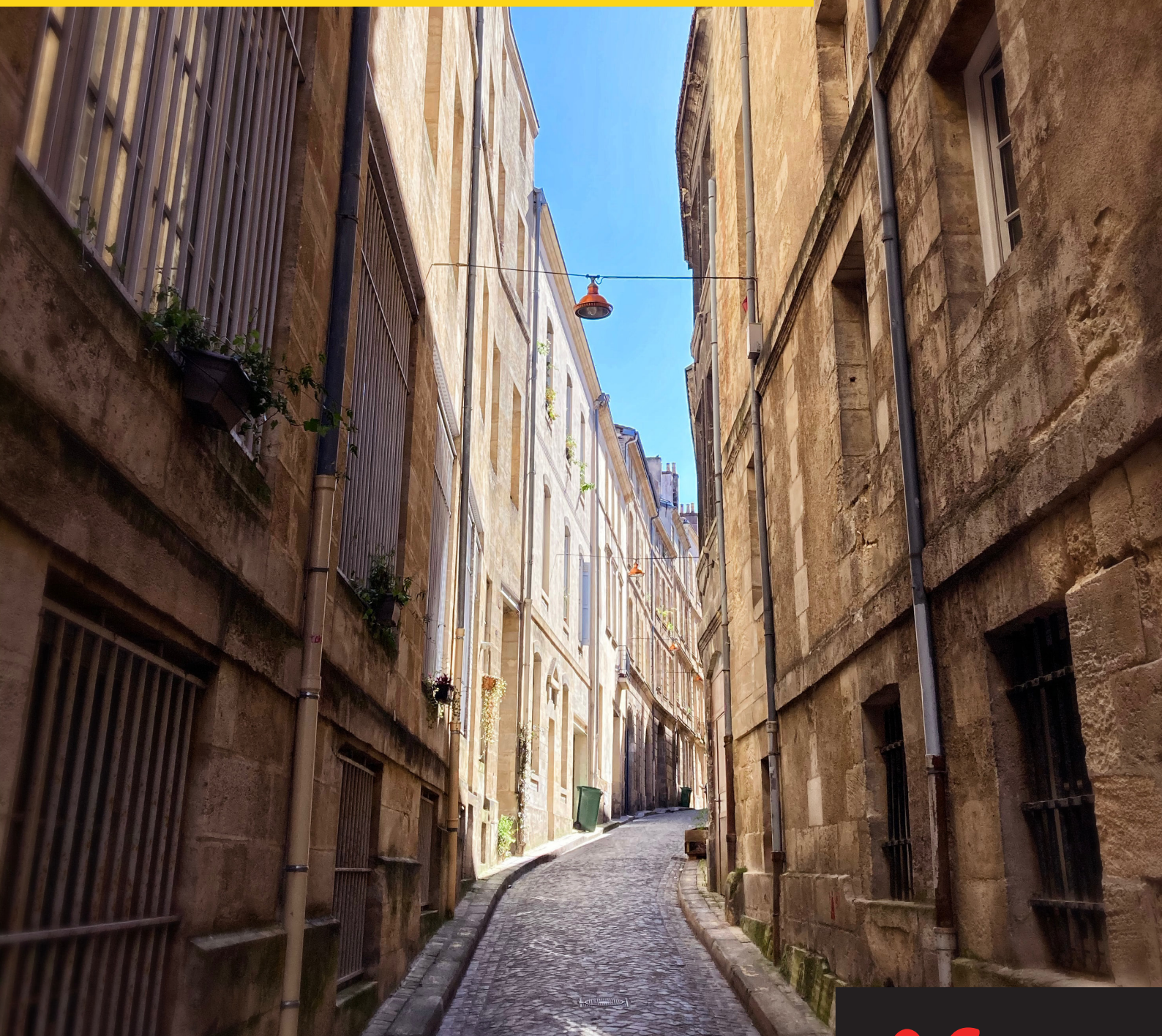

FACADE SOLUTION: A COMPLETE PRODUCT RANGE

Facade solution is a cost effective secure solution for fibre to Home (FTTH) applications. FTTH facade solution offers a way of a simple installation which fully eliminates civil works in cities, towns or villages.

The solution is suitable for Single Dwelling Units (SDU) but also in case of Multi Dwelling Units (MDU).

Window cut protection clip

Facade distribution box

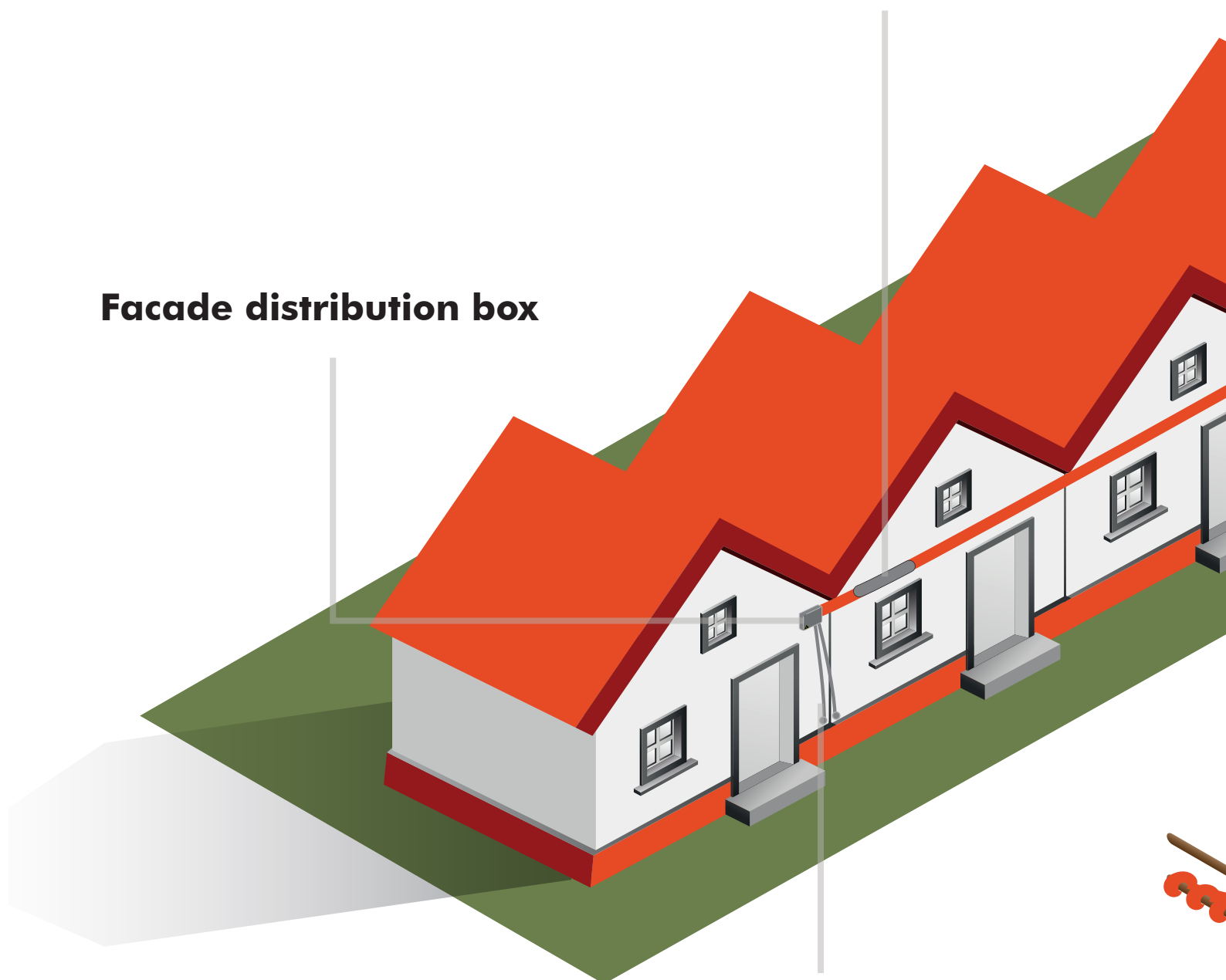

Indoor/outdoor drop cable

Facade distribution cable

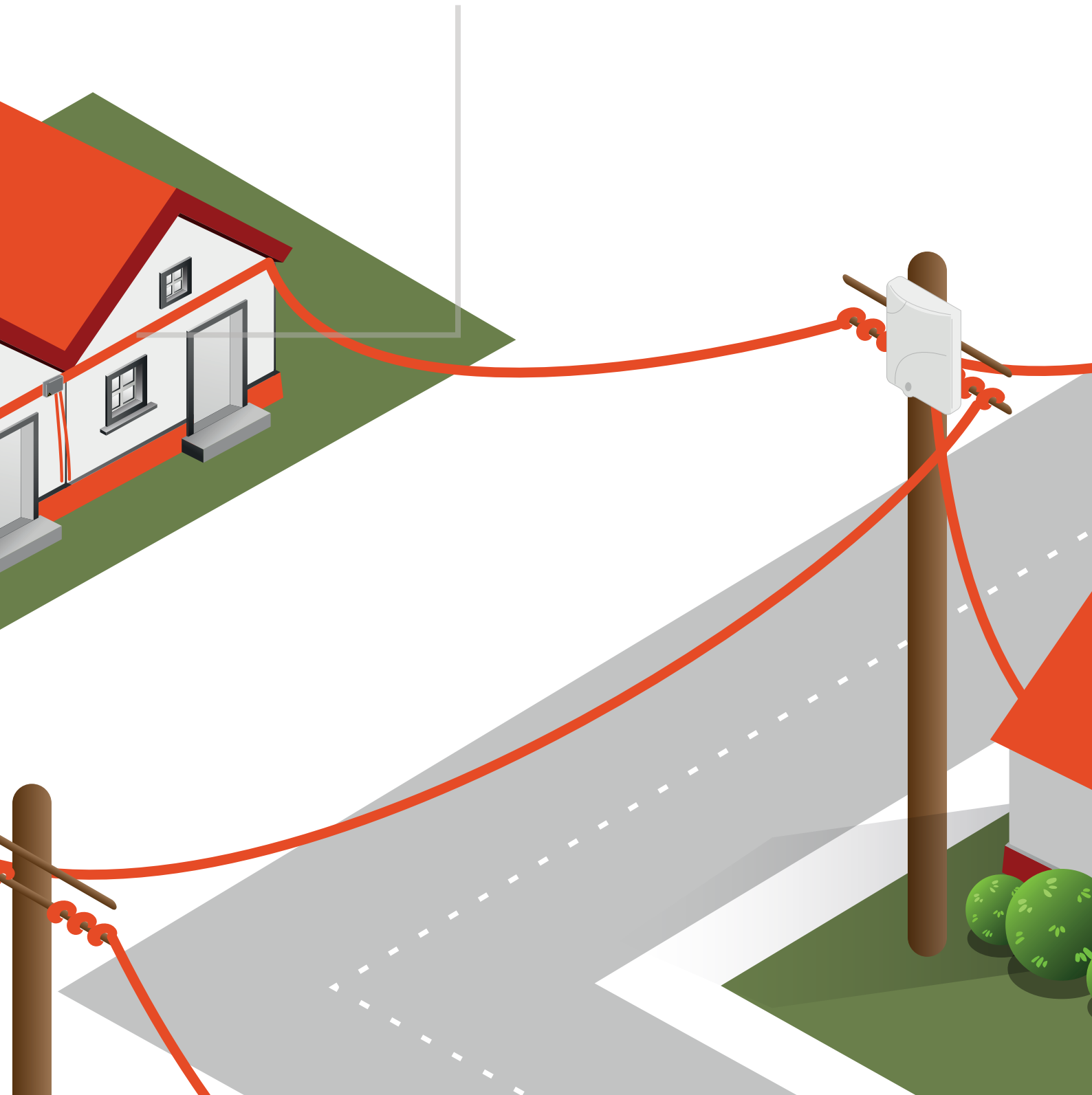

FACADE COMPONENTS & CABLES



Facade distribution cable

- Suitable for facade application in combination with our Walldrop facade distribution box
- Contains 24 easy strippable 900µm buffered fibre units
- Each 900µm unit is individually retractable
- Soft UV resistant outersheath allows easy mid-span access to the fibre units



Facade distribution box: WALLDROP

- Small volume offering an aesthetic solution
- Capable of connecting up to 10 subscribers
- Extensible product from 12 up to 36 splices
- Available with/without 1:4,1:16 optical splitters and with/without optical reflector
- IP55, IK8



Indoor/outdoor drop cables: Single Dwelling Units (SDU) & Multi Dwelling Units (MDU)

- Suitable for facade application in combination with our Walldrop facade distribution box
- Available in 1, 2 and 4 fibres in dual jacket design with LSZH inner sheath (CPR rating Cca)
- Available with 12 fibres (2x6) in single LSZH jacket (CPR rating Dca)



Window cut protection clip

- Fully compatible with our 24 optical fibres distribution cable
- Using the same sealing system of the walldrop distribution box
- IP55, IK8



Wall cable fixation

- Compatible with our cable, plug + plastic collier
- UV resistant

FOCUS ON... FACADE CABLE



Facade distribution cable has been design to match perfectly with the walldrop façade box

Radial Strength Members (Fibre Reinforced Plastic)

UV resistant LSZH outersheath

Fully dielectric

Watertight

Description and application

This cable has a capacity of 24 fibres. Acces to the fibres by window cut is quick and easy thanks to a flexible, UV resistant sheathing material. Each fibre is sheathed at $900\mu\text{m}$ and can be pulled back on more than 1m to easily connect the facade distribution box.

This cable has been designed to be compatible with the facade box. The Walldrop is discrete, flexible and brings lots of functionalities for future network evolutions : splitters, reflectors and extension kits to increase splicing capacity.





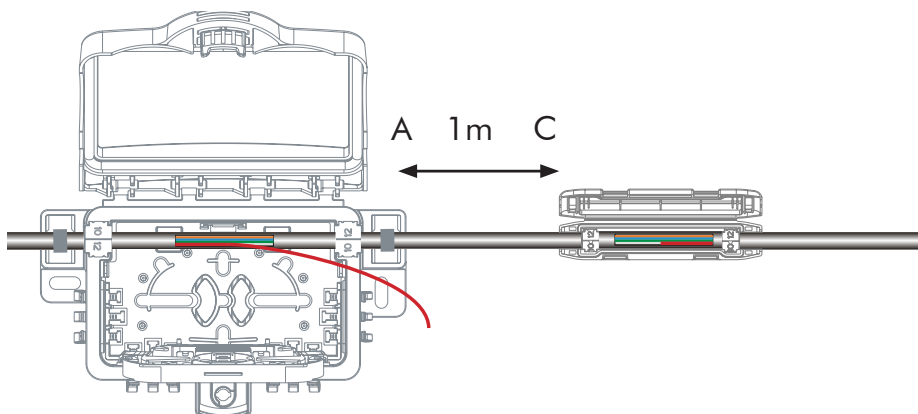

The extraction method

Distance of 1m to the left or to the right side of the walldrop

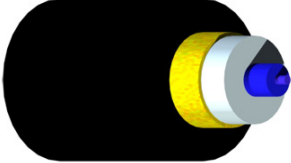

PRODUCT REFERENCES

<p>Distribution cable</p>	<p>SP1859 24 optical fibres</p>	
<p>Facade branching box</p>	<p>Walldrop 12 optical fibres Walldrop 36 optical fibres Walldrop with Splitters and/ or reflectors</p>	
<p>Single dwelling units drop cable</p>	<p>Single dwelling units drop 1 or 2 optical fibres SP1869, SP1249 and SP1892</p>	
<p>Multiple dwelling units drop cable</p>	<p>SP1833 6 or 12 optical fibres</p>	
<p>Branching box extension kit</p>	<p>Heighten Lid kit with Splitters Heighten Lid kit without splitters</p>	
<p>Window protection clip</p>	<p>Protection Clip</p>	

BENEFITS

Economic

- Only one distribution cable on the facade.
- Connection as close as possible to the dwellings.
- Very small box size.

Flexibility

- The Walldrop box can be placed anywhere on the cable.
- The Walldrop can be used as a flexibility point on the network with the integration of 1:4 or 1:16 splitters.
- The splicing capacity is 12 in the standard version but can be increased up to 36 splicing by means of a retrofittable extension kit.
- The Walldrop is available in grey or black.



DEDICATED SERVICES FOR TELECOM OPERATORS AND INSTALLERS

Building upon decades of experience in cabling, supply chain and engineering, Nexans offers its customers innovative services and digital solutions aimed at contributing to your operational and financial performance.



ENGINEERING AND TRAININGS

- In-depth training for installation and maintenance teams
- Integration of active equipment and power systems inside outdoor cabinets
- Delivery to site of preconfigured and integrated solution for a reliable, fast and cost effective deployment



ADVANCED LOGISTICS

The end-to-end cable logistics solution for traceability and full view on stock location, and availability

- On-time execution with just-in-time delivery
- Project site congestion reduction
- Budget control
- Securitisation of materials and equipments until the last minute



SMART INVENTORY MANAGEMENT

Based on RFID technology and demand driven supply models to easily monitor your stocks

- Real-time stock visibility
- Stock consumption follow-up in real time
- Quick reception process
- Fast and easy physical stock counting



CONNECTED DRUMS

Drum tracking & geolocation

- Automatic delivery notification
- Cable theft detection
- Residual length management
- Full fleet geolocation

Nexans Telecom

4 allée de l'Arche
CS70088
92070 Paris La Défense Cedex
contact.telecominfra@nexans.com
www.nexans.com

Follow us



Nexans Telecom