

# TTGI3

## HEAT-SHRINKABLE THREE CORE XLPE INDOOR TERMINATION

Up to 36 kV

6/10	(12)	kV
6.35/11	(12)	kV
8.7/15	(17.5)	kV
12/20	(24)	kV
12.7/22	(24)	kV
18/30	(36)	kV
19/33	(36)	kV

### Application

Heat-shrinkable terminations for three core polymeric cables, are widely used by power utilities and in industrial applications.

An earthing kit for both copper wires and copper tape screen, is included in the kit.

For use indoor in controlled environmental conditions.

### Design

1. Cable lug (supplied on request).
2. Water sealing mastic.
3. Anti-tracking heat-shrinkable tube.
4. Anti-tracking sheds (only for 36TTGI3).
5. Stress control heat-shrinkable tube.
6. Stress control mastic.
7. Break-out.
8. Flexible tinned copper braid.

### Specifications and standards

Meets the requirements of CENELEC HD 629.1 and IEC 60502-4.

17TTGI3 & 24TTGI3

36TTGI3

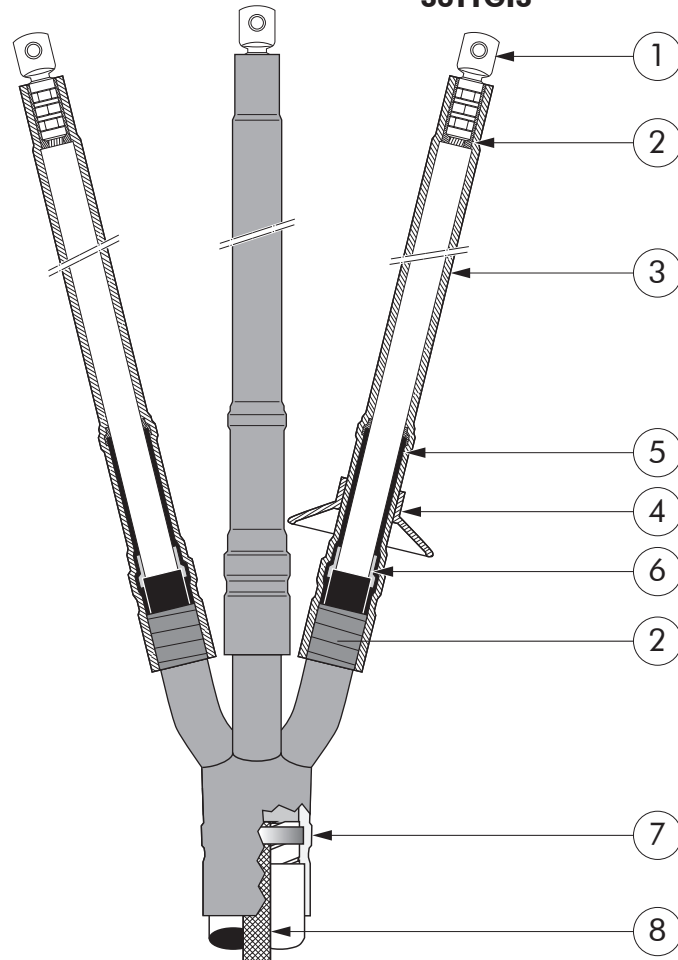

Termination type	Voltage Um (kV)	Conductor sizes (mm <sup>2</sup> )	
		min	max
17TTGI3	12 & 17.5	25	630
24TTGI3	24	25	630
36TTGI3	36	35	400

08/2011

## Kit contents

The complete TTGI3 termination kit comprises the following components:

The kit also comprises installation instructions, roll springs, a metallic clamp and an earthing lug for copper screen wires.

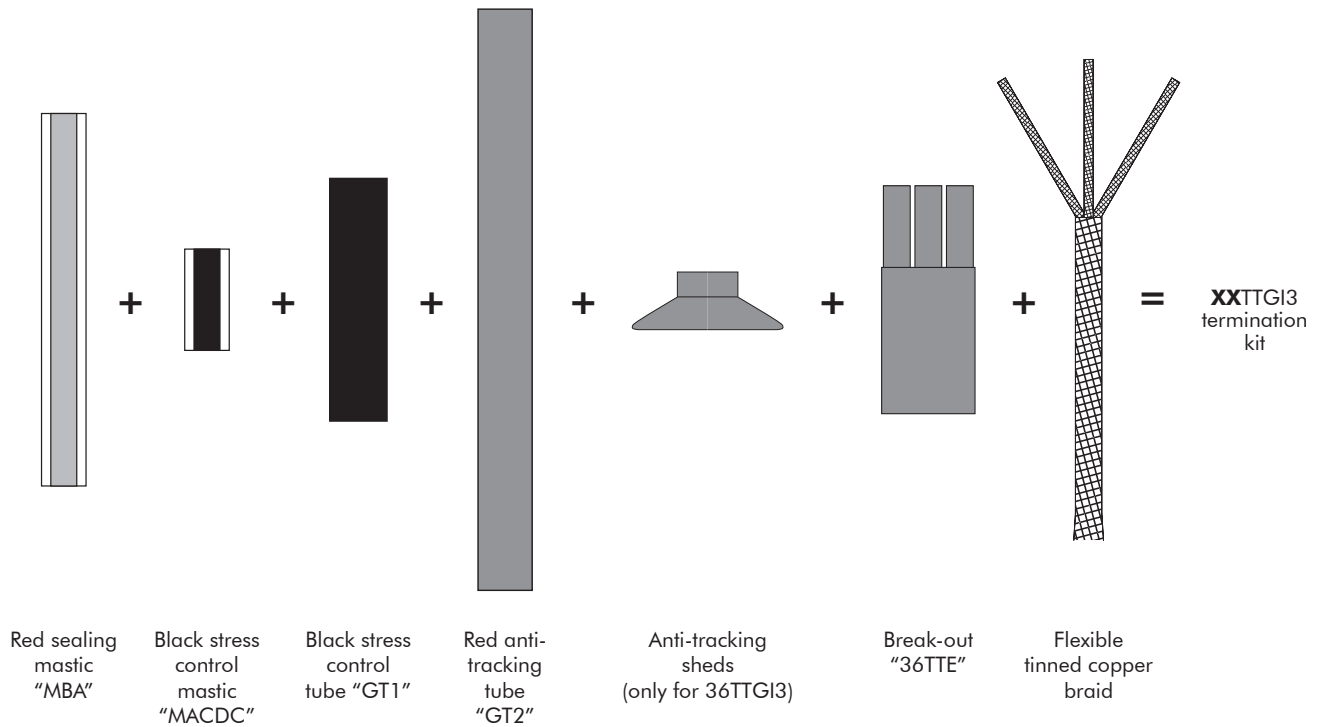

## Ordering instructions

Select the part number corresponding to both system voltage and conductor size.

### Example:

The cable is 12 kV, 3 x 150 mm<sup>2</sup> stranded aluminium, with an individual copper tape screen and a steel wire armour.  
Order: 17TTGI3.300w.

Ordering part number	Voltage U <sub>0</sub> /U (kV)	Conductor size range (mm <sup>2</sup> )	
		min	max
17TTGI3.50w	6/10 & 6.35/11 & 8.7/15	25	50
17TTGI3.120w	6/10 & 6.35/11 & 8.7/15	70	120
17TTGI3.300w	6/10 & 6.35/11 & 8.7/15	150	300
17TTGI3.630w	6/10 & 6.35/11 & 8.7/15	400	630
24TTGI3.95w	12/20 & 12.7/22	25	95
24TTGI3.240w	12/20 & 12.7/22	50	240
24TTGI3.630w	12/20 & 12.7/22	300	630
36TTGI3.120w	18/30 & 19/33	35	120
36TTGI3.300w	18/30 & 19/33	150	300
36TTGI3.400w	18/30 & 19/33	240	400

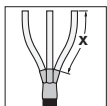

For tail length 'X' of 1200 mm.  
Order: -1200 mm.

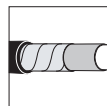

For use with copper tape screened cables. No further earthing device is necessary.

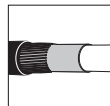

For use with copper wire screened cables. No further earthing device is necessary.



For use with other cable types. Please contact our representative.

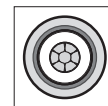

For use with single core cables: see TTGI1.

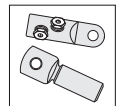

Can be supplied with all common types of cable lugs.